



SGM8925/SGM8927

110kHz, 6.4 μ A, Rail-to-Rail Output CMOS Operational Amplifiers

GENERAL DESCRIPTION

The SGM8925 (single) and SGM8927 (single with shutdown) are low offset voltage, low power, voltage feedback amplifiers. These devices can operate from 1.6V to 5.5V single supply, and consume only 6.4 μ A quiescent current. They provide a wide input common mode voltage range and rail-to-rail output voltage swing. This feature makes SGM8925/7 appropriate for buffering ASIC.

The SGM8925/7 offer a gain-bandwidth product of 110kHz and an ultra-low input bias current of 1pA. They are well suited for piezoelectric sensors, integrators and photodiode amplifiers.

The SGM8925/7 are designed into a wide range of applications, such as battery-powered instrumentation, safety monitoring, portable systems, and transducer interface circuits in low power systems.

The SGM8925 is available in Green SOT-23-5, SC70-5, MSOP-8 and SOIC-8 packages. The SGM8927 is available in Green SOT-23-6, MSOP-8 and SOIC-8 packages. They are specified over the extended -40°C to +85°C temperature range.

FEATURES

- **Low Offset Voltage: 0.6mV (MAX)**
- **Unity-Gain Stable**
- **Gain-Bandwidth Product: 110kHz**
- **Rail-to-Rail Output**
- **Supply Voltage Range: 1.6V to 5.5V**
- **Low Quiescent Current: 6.4 μ A (TYP)**
- **-40°C to +85°C Operating Temperature Range**
- **Small Packaging:**
 - SGM8925 Available in Green SOT-23-5, SC70-5, SOIC-8 and MSOP-8 Packages**
 - SGM8927 Available in Green SOT-23-6, SOIC-8 and MSOP-8 Packages**

APPLICATIONS

ASIC Input or Output Amplifiers
Piezoelectric Transducer Amplifiers
Battery-Powered Equipment
Portable Equipment
Sensor Interfaces
Medical Instrumentation
Mobile Communications
Audio Outputs
Smoke Detectors
Mobile Telephones
Notebook PCs
PCMCIA Cards

PACKAGE/ORDERING INFORMATION

MODEL	PACKAGE DESCRIPTION	SPECIFIED TEMPERATURE RANGE	ORDERING NUMBER	PACKAGE MARKING	PACKING OPTION
SGM8925	SC70-5	-40°C to +85°C	SGM8925YC5G/TR	SACXX	Tape and Reel, 3000
	SOT-23-5	-40°C to +85°C	SGM8925AYN5G/TR	SADXX	Tape and Reel, 3000
	SC70-5	-40°C to +85°C	SGM8925BYC5G/TR	ST9XX	Tape and Reel, 3000
	SOT-23-5	-40°C to +85°C	SGM8925BYN5G/TR	SAEXX	Tape and Reel, 3000
	SOIC-8	-40°C to +85°C	SGM8925YS8G/TR	SGM 8925YS8 XXXXX	Tape and Reel, 2500
	MSOP-8	-40°C to +85°C	SGM8925YMS8G/TR	SGM8925 YMS8 XXXXX	Tape and Reel, 3000
SGM8927	SOT-23-6	-40°C to +85°C	SGM8927YN6G/TR	SAFXX	Tape and Reel, 3000
	SOIC-8	-40°C to +85°C	SGM8927YS8G/TR	SGM 8927YS8 XXXXX	Tape and Reel, 2500
	MSOP-8	-40°C to +85°C	SGM8927YMS8G/TR	SGM8927 YMS8 XXXXX	Tape and Reel, 3000

MARKING INFORMATION

NOTE: XX = Date Code. XXXXX = Date Code and Vendor Code.

SC70-5/SOT-23-5/SOT-23-6

YYY X X

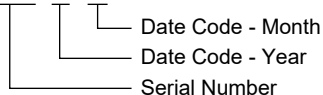

SOIC-8/MSOP-8

XXXXX

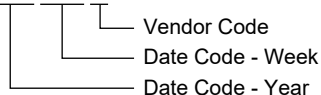

Green (RoHS & HSF): SG Micro Corp defines "Green" to mean Pb-Free (RoHS compatible) and free of halogen substances. If you have additional comments or questions, please contact your SGMICRO representative directly.

SGM8925 SGM8927

110kHz, 6.4µA, Rail-to-Rail Output CMOS Operational Amplifiers

ABSOLUTE MAXIMUM RATINGS

Supply Voltage, +Vs to -Vs	6V
Input Common Mode Voltage Range	(-Vs) - 0.1V to (+Vs) - 1.3V
Junction Temperature	+150°C
Storage Temperature Range	-65°C to +150°C
Lead Temperature (Soldering, 10s)	+260°C
ESD Susceptibility	
HBM	4000V
MM	400V

RECOMMENDED OPERATING CONDITIONS

Operating Temperature Range	-40°C to +85°C
-----------------------------------	----------------

OVERSTRESS CAUTION

Stresses beyond those listed in Absolute Maximum Ratings may cause permanent damage to the device. Exposure to absolute maximum rating conditions for extended periods

may affect reliability. Functional operation of the device at any conditions beyond those indicated in the Recommended Operating Conditions section is not implied.

ESD SENSITIVITY CAUTION

This integrated circuit can be damaged if ESD protections are not considered carefully. SGMICRO recommends that all integrated circuits be handled with appropriate precautions. Failure to observe proper handling and installation procedures can cause damage. ESD damage can range from subtle performance degradation to complete device failure. Precision integrated circuits may be more susceptible to damage because even small parametric changes could cause the device not to meet the published specifications.

DISCLAIMER

SG Micro Corp reserves the right to make any change in circuit design, or specifications without prior notice.

PIN CONFIGURATIONS

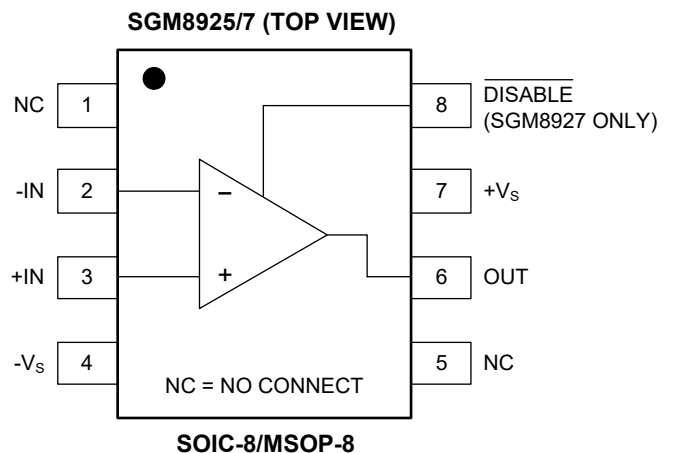
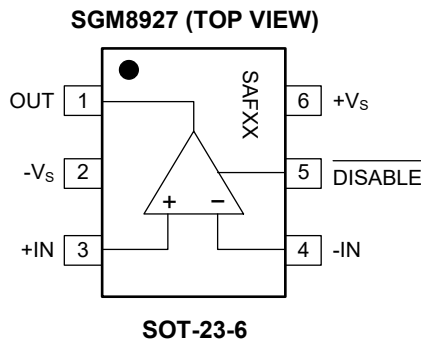
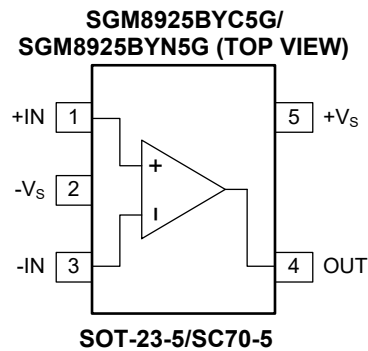
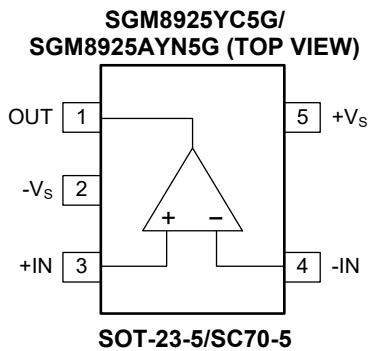

ELECTRICAL CHARACTERISTICS

($V_S = 5V$, $V_{OUT} = V_S/2$, Full = $-40^{\circ}C$ to $+85^{\circ}C$, typical values are at $T_A = +25^{\circ}C$, unless otherwise noted.)

PARAMETER	CONDITIONS	TEMP	MIN	TYP	MAX	UNITS
DC Performance						
Input Offset Voltage (V_{OS})	$V_{CM} = V_S/2$	+25°C		0.13	0.6	mV
		+25°C	SGM8925YC5G only		0.75	
Input Offset Voltage Drift ($\Delta V_{OS}/\Delta T$)		Full		2.5		$\mu V/^{\circ}C$
Open-Loop Voltage Gain (A_{OL})	$R_L = 100k\Omega$ to $V_S/2$, $V_{OUT} = 0.05V$ to $4.95V$	+25°C		93		dB
		+25°C	80	88		
		Full	78			
Input Characteristics						
Common Mode Rejection Ratio (CMRR)	$V_{CM} = -0.1V$ to $3.7V$	+25°C	70	85		dB
		Full	68			
Output Characteristics						
Output Voltage Swing from Rail	$R_L = 10k\Omega$ to $V_S/2$	+25°C		21	36	mV
		Full			40	
	$R_L = 2k\Omega$ to $V_S/2$	+25°C		80	100	
		Full			110	
Output Short-Circuit Current (I_{SC})	$R_L = 10\Omega$ to $V_S/2$	+25°C	29	36		mA
		Full	23			
Power-Down (SGM8927 Only)						
Logic Low Voltage (V_{IL})		+25°C			0.8	V
Logic High Voltage (V_{IH})		+25°C	2			
Power Supply						
Quiescent Current (I_Q)	$I_{OUT} = 0mA$	+25°C		6.4	11.5	μA
		Full			13.5	
Supply Current when Disabled (SGM8927 Only)		+25°C		0.1	1.5	μA
Power Supply Rejection Ratio (PSRR)	$V_S = 1.6V$ to $5.5V$, $V_{CM} = 0.3V$	+25°C	64	77		dB
		Full	62			
Dynamic Performance						
Gain-Bandwidth Product (GBP)	$R_L = 100k\Omega$, $C_L = 100pF$, $V_{CM} = 2.5V$	+25°C		110		kHz
Slew Rate (SR)	$V_{CM} = 2.5V$	+25°C		0.04		$V/\mu s$
Noise Performance						
Input Voltage Noise Density (e_n)	$f = 1kHz$	+25°C		105		nV/\sqrt{Hz}

ELECTRICAL CHARACTERISTICS (continued)

($V_S = 1.6V$, $V_{CM} = 0.3V$, $V_{OUT} = V_S/2$, Full = $-40^{\circ}C$ to $+85^{\circ}C$, typical values are at $T_A = +25^{\circ}C$, unless otherwise noted.)

PARAMETER	CONDITIONS	TEMP	MIN	TYP	MAX	UNITS
DC Performance						
Input Offset Voltage (V_{OS})		+25°C		0.28	0.6	mV
	SGM8925YC5G only	+25°C			0.75	
Input Offset Voltage Drift ($\Delta V_{OS}/\Delta T$)		Full		1.8		$\mu V/^{\circ}C$
Open-Loop Voltage Gain (A_{OL})	$R_L = 100k\Omega$ to $V_S/2$, $V_{OUT} = 0.05V$ to $1.55V$	+25°C		99		dB
		+25°C	80	91		
	Full	78				
Input Characteristics						
Common Mode Rejection Ratio (CMRR)	$V_{CM} = -0.1V$ to $0.3V$	+25°C	65	78		dB
		Full	62			
Output Characteristics						
Output Voltage Swing from Rail	$R_L = 10k\Omega$ to $V_S/2$	+25°C		13	25	mV
		Full			30	
	$R_L = 2k\Omega$ to $V_S/2$	+25°C		63	87	
		Full			95	
Output Short-Circuit Current (I_{SC})	$R_L = 10\Omega$ to $V_S/2$	+25°C	0.5	2.6		mA
		+25°C	0.35			
		Full	0.3			
Power-Down (SGM8927 Only)						
Logic Low Voltage (V_{IL})		+25°C			0.4	V
Logic High Voltage (V_{IH})		+25°C	1.1			
Power Supply						
Quiescent Current (I_Q)	$I_{OUT} = 0mA$	+25°C		5.8	10.5	μA
		Full			13	
Supply Current when Disabled (SGM8927 Only)		+25°C		0.1	1.5	μA
Dynamic Performance						
Gain-Bandwidth Product (GBP)	$R_L = 100k\Omega$, $C_L = 100pF$	+25°C		110		kHz
Slew Rate (SR)		+25°C		0.04		V/ μs
Noise Performance						
Input Voltage Noise Density (e_n)	$f = 1kHz$	+25°C		105		nV/ \sqrt{Hz}

TYPICAL PERFORMANCE CHARACTERISTICS

At $T_A = +25^\circ\text{C}$, $V_S = 5\text{V}$, unless otherwise noted.

Small Signal Step Response

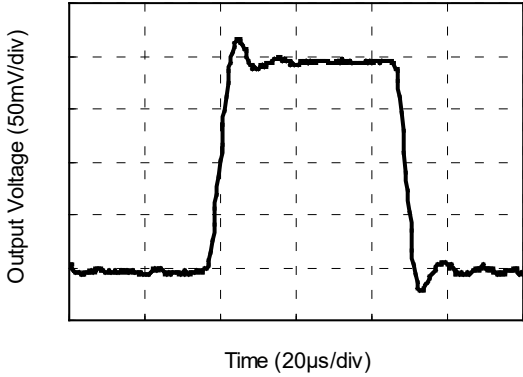

Large Signal Step Response

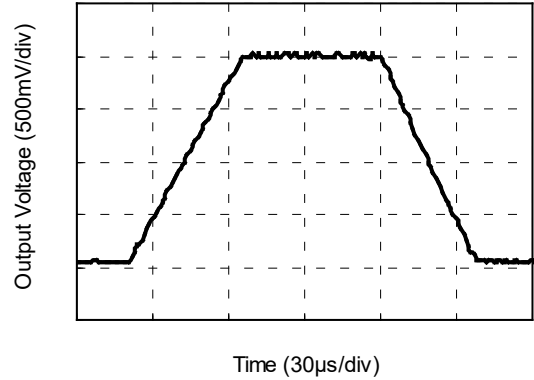

CMRR and PSRR vs. Frequency

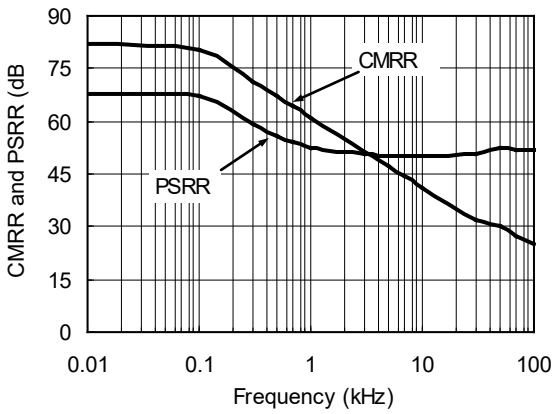

Input Voltage Noise Spectral Density vs. Frequency

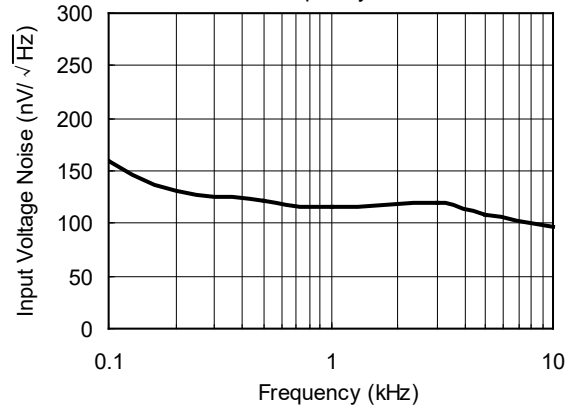

Quiescent Current vs. Temperature

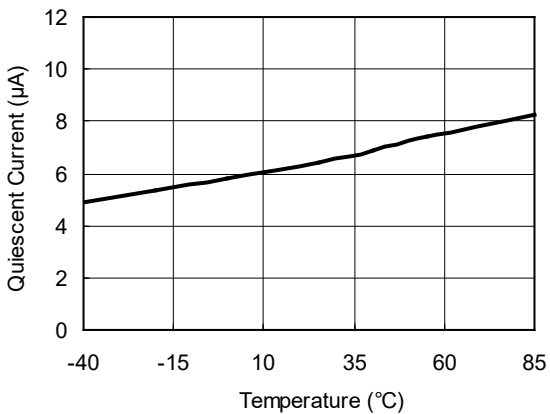

Open-Loop Voltage Gain vs. Temperature

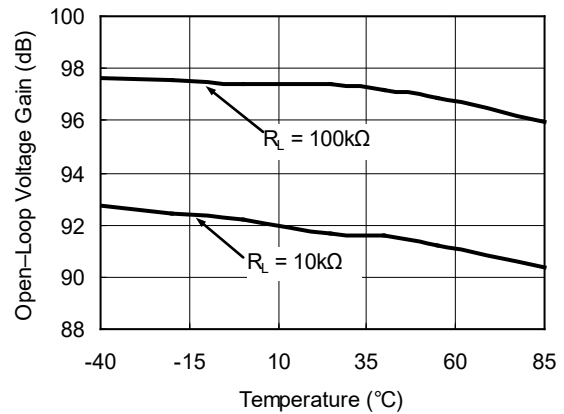

TYPICAL PERFORMANCE CHARACTERISTICS (continued)

At $T_A = +25^\circ\text{C}$, $V_S = 5\text{V}$, unless otherwise noted.

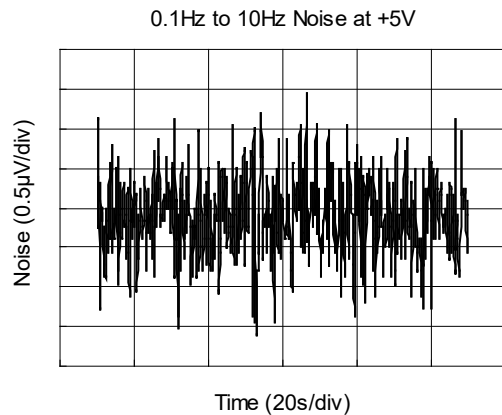
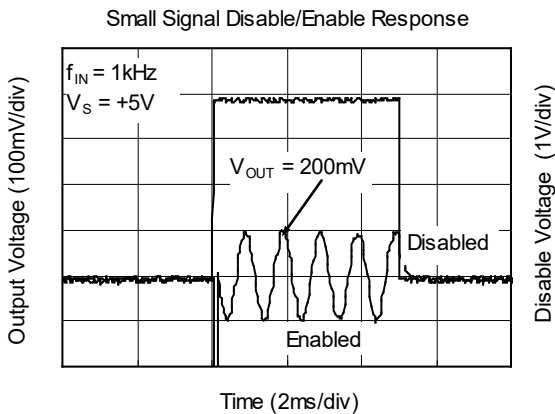
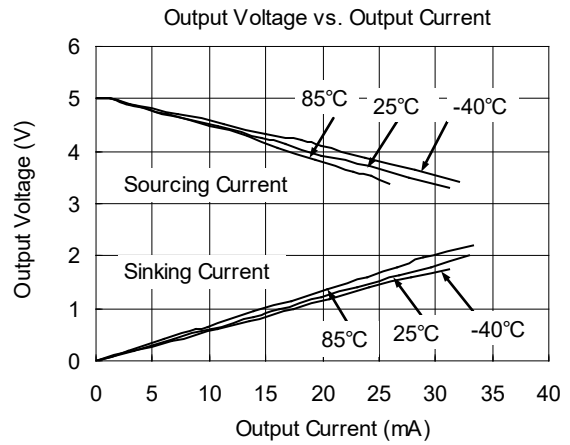
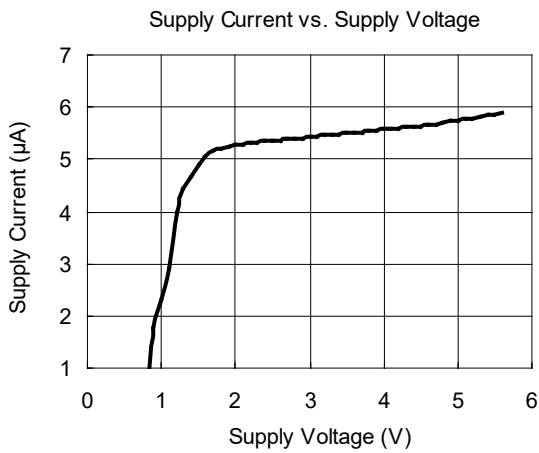
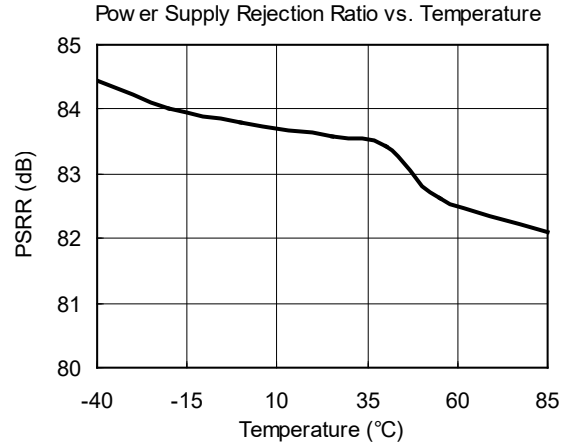
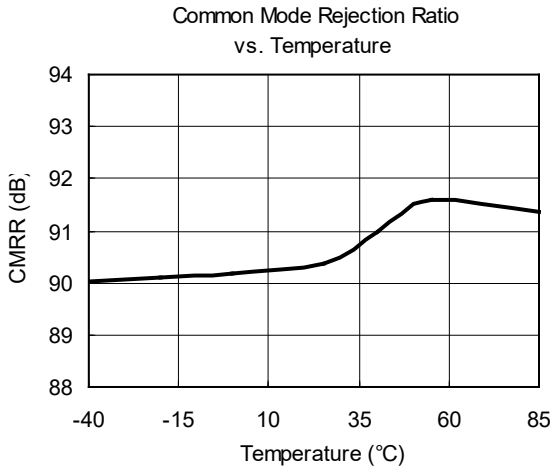

TYPICAL PERFORMANCE CHARACTERISTICS (continued)

At $T_A = +25^\circ\text{C}$, $V_S = 5\text{V}$, unless otherwise noted.

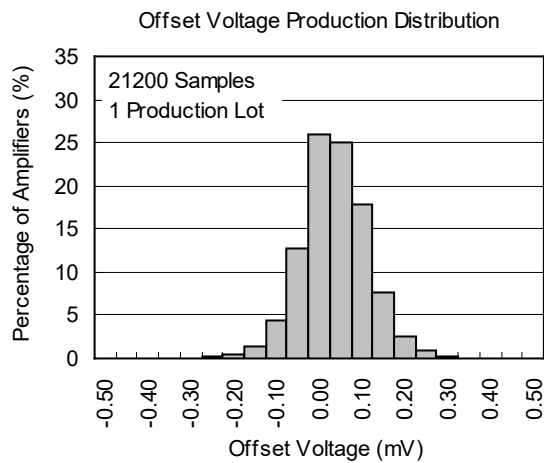
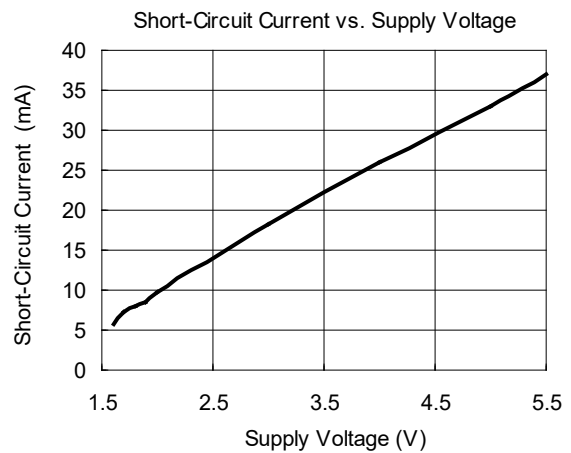
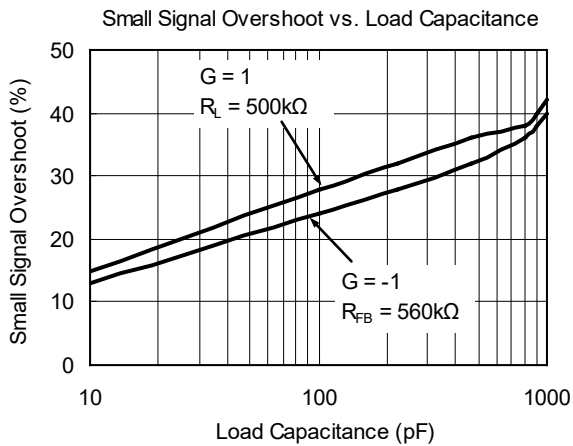

REVISION HISTORY

NOTE: Page numbers for previous revisions may differ from page numbers in the current version.

JULY 2023 – REV.A.3 to REV.A.4		Page
Updated Package Outline Dimensions section		10
DECEMBER 2014 – REV.A.2 to REV.A.3		Page
Added SC70-5 Package from product preview to production data		1
Added Ordering Information of SC70-5 package for SGM8925		2
Added SC70-5 package for SGM8925		3
DECEMBER 2013 – REV.A.1 to REV.A.2		Page
Changed Electrical Characteristics section		5
Added input offset voltage (V_{OS}) max value of SGM8925YC5G		5
Changed Electrical Characteristics section		6
Added input offset voltage (V_{OS}) max value of SGM8925YC5G		6
Added output short-circuit current (I_{SC}) min value of SGM8925YC5G		6
Changed output short-circuit current (I_{SC}) min value from 0.4V to 0.3V		6
MAY 2013 – REV.A to REV.A.1		Page
Changed Electrical Characteristics section		5
Deleted open-loop voltage gain (A_{OL}) min value in $R_L = 100k\Omega$ to $V_S/2$ test condition		5
Changed Electrical Characteristics section		6
Deleted open-loop voltage gain (A_{OL}) min value in $R_L = 100k\Omega$ to $V_S/2$ test condition		6
Changes from Original (AUGUST 2012) to REV.A		Page
Changed from product preview to production data		All

PACKAGE OUTLINE DIMENSIONS

SC70-5

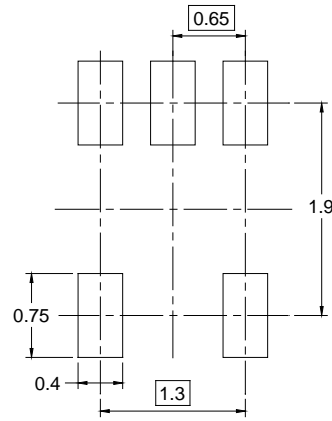
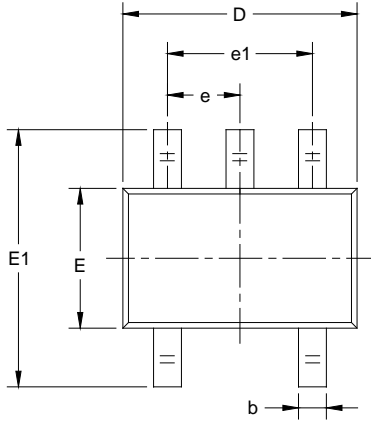

RECOMMENDED LAND PATTERN (Unit: mm)

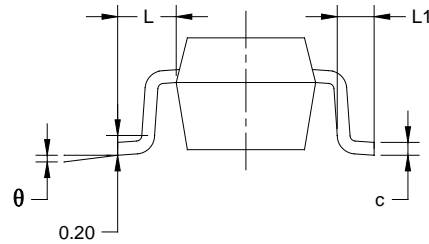
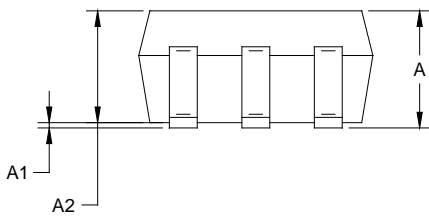

Symbol	Dimensions In Millimeters		Dimensions In Inches	
	MIN	MAX	MIN	MAX
A	0.800	1.100	0.031	0.043
A1	0.000	0.100	0.000	0.004
A2	0.800	1.000	0.031	0.039
b	0.150	0.350	0.006	0.014
c	0.080	0.220	0.003	0.009
D	2.000	2.200	0.079	0.087
E	1.150	1.350	0.045	0.053
E1	2.150	2.450	0.085	0.096
e	0.65 TYP		0.026 TYP	
e1	1.300 BSC		0.051 BSC	
L	0.525 REF		0.021 REF	
L1	0.260	0.460	0.010	0.018
θ	0°	8°	0°	8°

NOTES:

1. Body dimensions do not include mode flash or protrusion.
2. This drawing is subject to change without notice.

PACKAGE OUTLINE DIMENSIONS

SOT-23-5

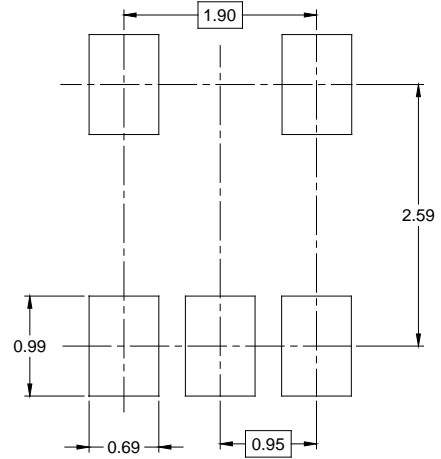
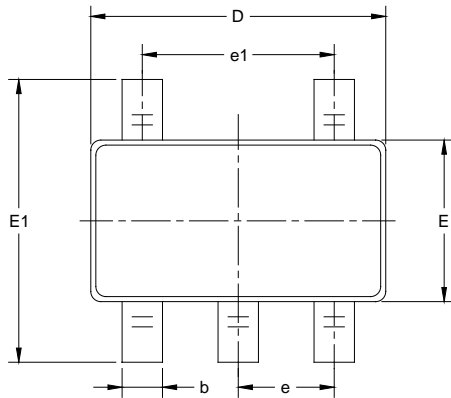

RECOMMENDED LAND PATTERN (Unit: mm)

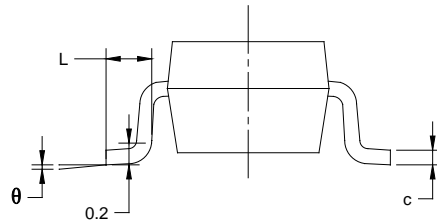
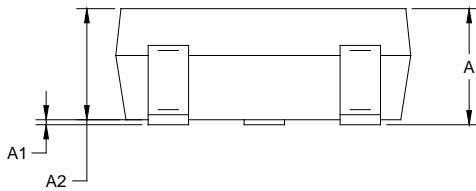

Symbol	Dimensions In Millimeters		Dimensions In Inches	
	MIN	MAX	MIN	MAX
A	1.050	1.250	0.041	0.049
A1	0.000	0.100	0.000	0.004
A2	1.050	1.150	0.041	0.045
b	0.300	0.500	0.012	0.020
c	0.100	0.200	0.004	0.008
D	2.820	3.020	0.111	0.119
E	1.500	1.700	0.059	0.067
E1	2.650	2.950	0.104	0.116
e	0.950 BSC		0.037 BSC	
e1	1.900 BSC		0.075 BSC	
L	0.300	0.600	0.012	0.024
θ	0°	8°	0°	8°

NOTES:

1. Body dimensions do not include mode flash or protrusion.
2. This drawing is subject to change without notice.

PACKAGE OUTLINE DIMENSIONS

SOT-23-6

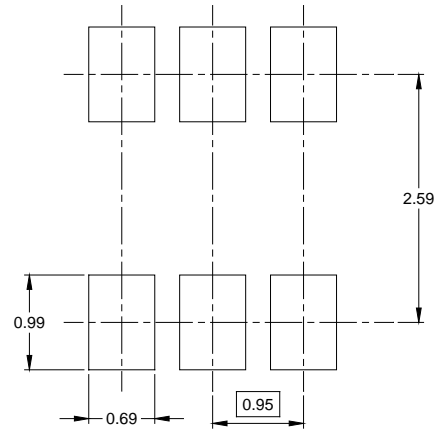
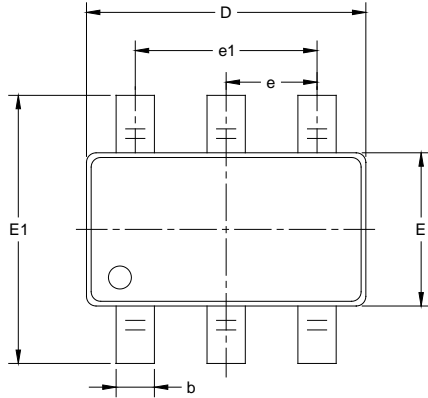

RECOMMENDED LAND PATTERN (Unit: mm)

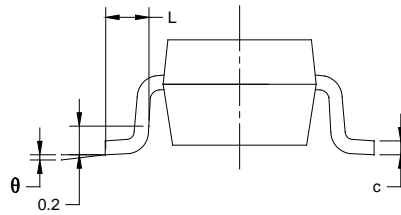
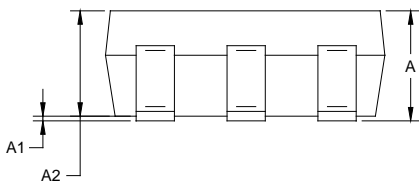

Symbol	Dimensions In Millimeters		Dimensions In Inches	
	MIN	MAX	MIN	MAX
A	1.050	1.250	0.041	0.049
A1	0.000	0.100	0.000	0.004
A2	1.050	1.150	0.041	0.045
b	0.300	0.500	0.012	0.020
c	0.100	0.200	0.004	0.008
D	2.820	3.020	0.111	0.119
E	1.500	1.700	0.059	0.067
E1	2.650	2.950	0.104	0.116
e	0.950 BSC		0.037 BSC	
e1	1.900 BSC		0.075 BSC	
L	0.300	0.600	0.012	0.024
θ	0°	8°	0°	8°

NOTES:

1. Body dimensions do not include mode flash or protrusion.
2. This drawing is subject to change without notice.

PACKAGE OUTLINE DIMENSIONS

SOIC-8

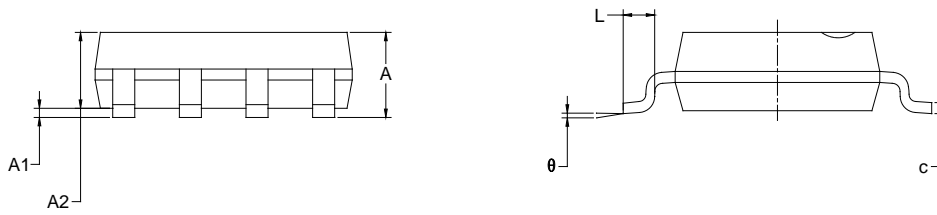
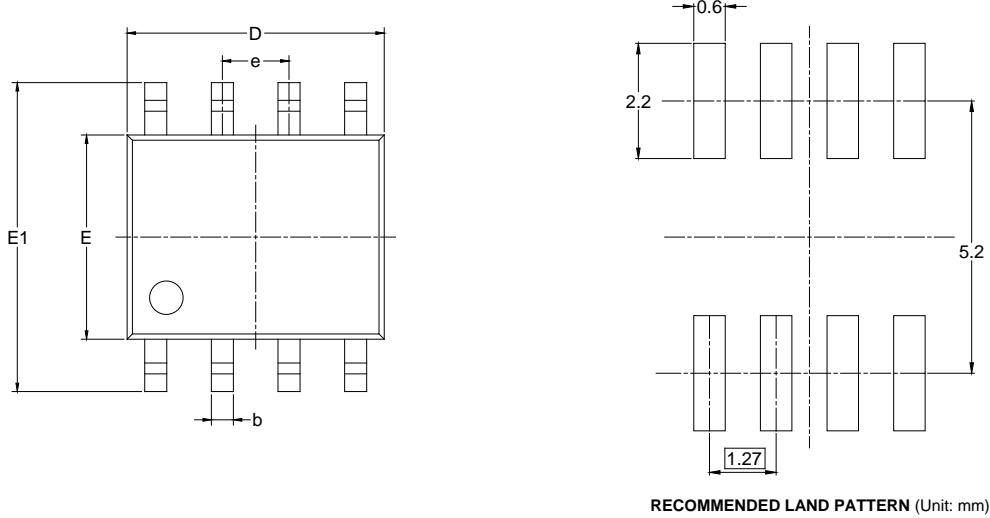

Symbol	Dimensions In Millimeters		Dimensions In Inches	
	MIN	MAX	MIN	MAX
A	1.350	1.750	0.053	0.069
A1	0.100	0.250	0.004	0.010
A2	1.350	1.550	0.053	0.061
b	0.330	0.510	0.013	0.020
c	0.170	0.250	0.006	0.010
D	4.700	5.100	0.185	0.200
E	3.800	4.000	0.150	0.157
E1	5.800	6.200	0.228	0.244
e	1.27 BSC		0.050 BSC	
L	0.400	1.270	0.016	0.050
θ	0°	8°	0°	8°

NOTES:
 1. Body dimensions do not include mode flash or protrusion.
 2. This drawing is subject to change without notice.

PACKAGE OUTLINE DIMENSIONS

MSOP-8

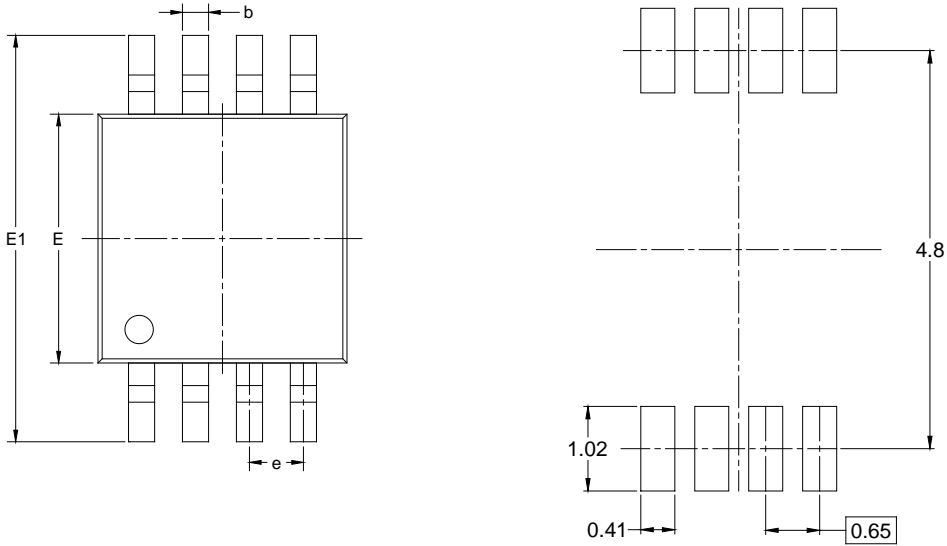

RECOMMENDED LAND PATTERN (Unit: mm)

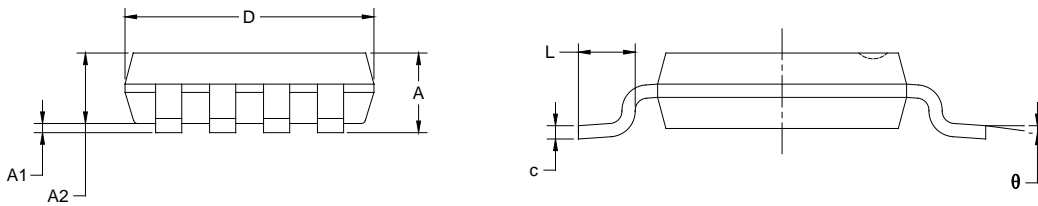

Symbol	Dimensions In Millimeters		Dimensions In Inches	
	MIN	MAX	MIN	MAX
A	0.820	1.100	0.032	0.043
A1	0.020	0.150	0.001	0.006
A2	0.750	0.950	0.030	0.037
b	0.250	0.380	0.010	0.015
c	0.090	0.230	0.004	0.009
D	2.900	3.100	0.114	0.122
E	2.900	3.100	0.114	0.122
E1	4.750	5.050	0.187	0.199
e	0.650 BSC		0.026 BSC	
L	0.400	0.800	0.016	0.031
θ	0°	6°	0°	6°

NOTES:

1. Body dimensions do not include mode flash or protrusion.
2. This drawing is subject to change without notice.

PACKAGE INFORMATION

TAPE AND REEL INFORMATION

REEL DIMENSIONS



TAPE DIMENSIONS



NOTE: The picture is only for reference. Please make the object as the standard.

KEY PARAMETER LIST OF TAPE AND REEL

Package Type	Reel Diameter	Reel Width W1 (mm)	A0 (mm)	B0 (mm)	K0 (mm)	P0 (mm)	P1 (mm)	P2 (mm)	W (mm)	Pin1 Quadrant
SC70-5	7"	9.5	2.40	2.50	1.20	4.0	4.0	2.0	8.0	Q3
SOT-23-5	7"	9.5	3.20	3.20	1.40	4.0	4.0	2.0	8.0	Q3
SOT-23-6	7"	9.5	3.23	3.17	1.37	4.0	4.0	2.0	8.0	Q3
SOIC-8	13"	12.4	6.40	5.40	2.10	4.0	8.0	2.0	12.0	Q1
MSOP-8	13"	12.4	5.20	3.30	1.50	4.0	8.0	2.0	12.0	Q1

D20001

PACKAGE INFORMATION

CARTON BOX DIMENSIONS



NOTE: The picture is only for reference. Please make the object as the standard.

KEY PARAMETER LIST OF CARTON BOX

Reel Type	Length (mm)	Width (mm)	Height (mm)	Pizza/Carton
7" (Option)	368	227	224	8
7"	442	410	224	18
13"	386	280	370	5

DD0002